

KENWOOD

TK-7180/ TK-8180
TK-7189/ TK-8189

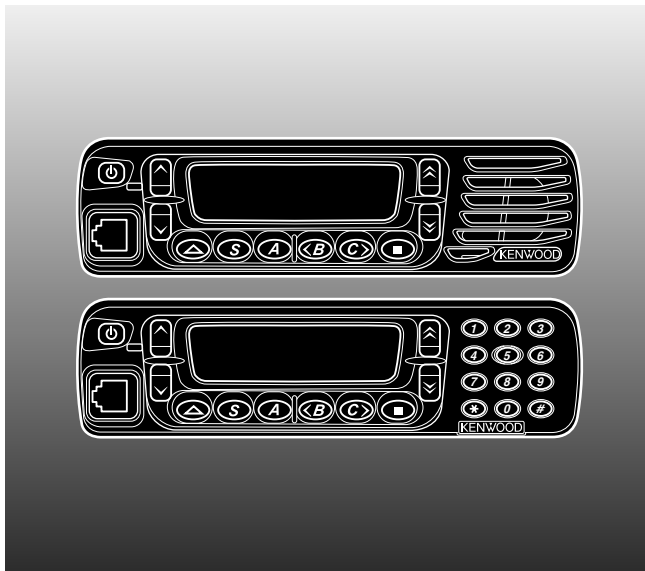

VHF FM TRANSCEIVER/ UHF FM TRANSCEIVER

INSTRUCTION MANUAL

ÉMETTEUR-RÉCEPTEUR FM VHF/ ÉMETTEUR-RÉCEPTEUR FM UHF

MODE D'EMPLOI

TRANSCÉPTOR FM VHF/ TRANSCÉPTOR FM UHF

MANUAL DE INSTRUCCIONES

RICETRASMETTITORE FM VHF/ RICETRASMETTITORE FM UHF

MANUALE DI ISTRUZIONI

VHF-FM-TRANSCEIVER/ UHF-FM-TRANSCEIVER

BEDIENUNGSANLEITUNG

VHF FM ZENDONTVANGER/ UHF FM ZENDONTVANGER

GEBRUIKSAANWIJZING

KENWOOD CORPORATION

© B62-1767-10 (E)
09 08 07 06 05 04 03 02 01

VHF FM TRANSCEIVER/
UHF FM TRANSCEIVER

TK-7180/ TK-8180

TK-7189/ TK-8189

INSTRUCTION MANUAL

KENWOOD CORPORATION

ENGLISH

THANK YOU

We are grateful you chose **KENWOOD** for your personal mobile applications. We believe this easy-to-use transceiver will provide dependable communications to keep personnel operating at peak efficiency.

KENWOOD transceivers incorporate the latest in advanced technology. As a result, we feel strongly that you will be pleased with the quality and features of this product.

MODELS COVERED BY THIS MANUAL

The models listed below are covered by this manual:

- **TK-7180:** VHF FM Transceiver
- **TK-7189:** VHF FM Transceiver (with front panel keypad)
- **TK-8180:** UHF FM Transceiver
- **TK-8189:** UHF FM Transceiver (with front panel keypad)

NOTICES TO THE USER

- ◆ Government law prohibits the operation of unlicensed transmitters within the territories under government control.
- ◆ Illegal operation is punishable by fine and/or imprisonment.
- ◆ Refer service to qualified technicians only.

SAFETY: It is important that the operator is aware of, and understands, hazards common to the operation of any transceiver.



- ◆ **EXPLOSIVE ATMOSPHERES (GASES, DUST, FUMES, etc.)**
Turn OFF your transceiver while taking on fuel or while parked in gasoline service stations. Do not carry spare fuel containers in the trunk of your vehicle if your transceiver is mounted in the trunk area.
- ◆ **INJURY FROM RADIO FREQUENCY TRANSMISSIONS**
Do not operate your transceiver when somebody is either touching the antenna or standing within 2 to 3 feet (60 to 90 cm) of it, to avoid the possibility of radio frequency burns or related physical injury.
- ◆ **DYNAMITE BLASTING CAPS**
Operating the transceiver within 500 feet (150 m) of dynamite blasting caps may cause them to explode. Turn OFF your transceiver when in an area where blasting is in progress, or where "TURN OFF TWO-WAY RADIO" signs have been posted. If you are transporting blasting caps in your vehicle, make sure they are carried in a closed metal box with a padded interior. Do not transmit while the caps are being placed into or removed from the container.

PRECAUTIONS

Observe the following precautions to prevent fire, personal injury, and transceiver damage.

- Do not attempt to configure the transceiver while driving; it is too dangerous.
- Do not disassemble or modify the transceiver for any reason.
- Do not expose the transceiver to long periods of direct sunlight, nor place it near heating appliances.
- Do not place the transceiver in excessively dusty, humid, or wet areas, nor on unstable surfaces.
- If an abnormal odor or smoke is detected coming from the transceiver, switch the transceiver power off immediately, and contact your **KENWOOD** dealer.
- Use of the transceiver while you are driving may be against traffic laws. Please check and observe the vehicle regulations in your area.
- Do not use options not specified by **KENWOOD**.



CAUTION

- ◆ The transceiver operates in **12 V** negative ground systems only! Check the battery polarity and voltage of the vehicle before installing the transceiver.
- ◆ Use only the supplied DC power cable or a **KENWOOD** optional DC power cable.
- ◆ Do not cut and/or remove the fuse holder on the DC power cable.



WARNING

For passenger safety, install the transceiver securely using the supplied mounting bracket and screw set so the transceiver will not break loose in the event of a collision.

CONTENTS

UNPACKING AND CHECKING EQUIPMENT	1
SUPPLIED ACCESSORIES	1
PREPARATION	2
TOOLS REQUIRED	2
POWER CABLE CONNECTION	2
INSTALLING THE TRANSCEIVER	3
GETTING ACQUAINTED	4
FRONT PANEL	4
REAR PANEL	4
DISPLAY	6
PROGRAMMABLE FUNCTIONS	7
BASIC OPERATIONS	8
OVERVIEW	8
SWITCHING POWER ON/ OFF	8
ADJUSTING THE VOLUME	8
SELECTING A ZONE AND CHANNEL	9
TRANSMITTING	9
RECEIVING	9
CONVENTIONAL SCAN	10
ADD TO SCAN/ DELETE FROM SCAN	10
SCAN REVERT	11
PRIORITY SCAN	11
QUIET TALK (QT)/ DIGITAL QUIET TALK (DQT)	12
OPERATOR SELECTABLE TONE (OST)	12
5-TONE SIGNALING	13
MAKING A SELCALL (SELECTIVE CALL)	13
TRANSMITTING A STATUS MESSAGE	13
RECEIVING SELCALLS AND STATUS MESSAGES	14
REVIEWING MESSAGES IN THE QUEUE MEMORY	14

FleetSync: ALPHANUMERIC 2-WAY PAGING FUNCTION	15
SELCALL (SELECTIVE CALLING)	15
STATUS MESSAGE	16
SHORT MESSAGES	17
LONG MESSAGES	17
GPS REPORT	17
DTMF (DUAL TONE MULTIE FREQUENCY) CALLS	18
MANUAL DIALING	18
AUTODIAL	18
REDIAL	18
CONNECT/ DISCONNECT IDs	19
DTMF SIGNALING	19
STUN	19
EMERGENCY CALLS	20
ADVANCED OPERATIONS	21
TALK AROUND	21
MONITOR/ SQUELCH OFF	21
SCRAMBLER	22
CLOCK	22
LCD BRIGHTNESS	23
HORN ALERT	23
PUBLIC ADDRESS (PA)	23
BACKGROUND OPERATIONS	24
TIME-OUT TIMER (TOT)	24
BUSY CHANNEL LOCKOUT (BCL)	24
SIGNAL STRENGTH INDICATOR	24
BEGINNING/ END OF TRANSMIT SIGNAL	24
VGS-1 OPTIONAL VOICE GUIDE & STORAGE UNIT	25
VOICE RECORDER	25
VOICE GUIDE	26

UNPACKING AND CHECKING EQUIPMENT

Note: The following unpacking instructions are for use by your **KENWOOD** dealer, an authorized **KENWOOD** service facility, or the factory.

Carefully unpack the transceiver. We recommend that you identify the items listed in the following table before discarding the packing material. If any items are missing or have been damaged during shipment, file a claim with the carrier immediately.

SUPPLIED ACCESSORIES

Item	Part Number	Quantity
DC power cable	E30-7523-XX	1
• Fuse (15 A)	F52-0024-XX	2
Mounting bracket	J29-0662-XX	1
Screw set: <ul style="list-style-type: none">• Self-tapping screw (4 pieces)• Hex-headed screw with washer (4 pieces)• Spring washer (4 pieces)• Flat washer (4 pieces)	N99-2039-XX	1
Instruction manual	B62-1767-XX	1

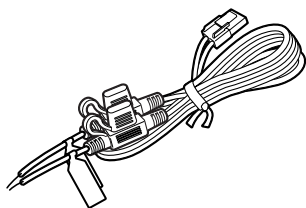

DC power cable
(with fuses)

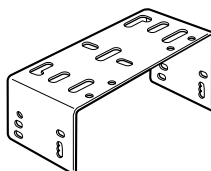

Mounting bracket

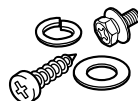

Screw set

PREPARATION



Various electronic equipment in your vehicle may malfunction if they are not properly protected from the radio frequency energy which is present while transmitting. Electronic fuel injection, anti-skid braking, and cruise control systems are typical examples of equipment that may malfunction. If your vehicle contains such equipment, consult the dealer for the make of vehicle and enlist his/her aid in determining if they will perform normally while transmitting.

Note: The following preparation instructions are for use by your **KENWOOD** dealer, an authorized **KENWOOD** service facility, or the factory.

TOOLS REQUIRED

Note: Before installing the transceiver, always check how far the mounting screws will extend below the mounting surface. When drilling mounting holes, be careful not to damage vehicle wiring or parts.

The following tools are required for installing the transceiver:

- 1/14 inch (6 mm) or larger electric drill
- 5/32 inch (4.2 mm) drill bit for the self-tapping screws
- Circle cutters

POWER CABLE CONNECTION



- ◆ The transceiver operates in **12 V** negative ground systems only! Check the battery polarity and voltage of the vehicle before installing the transceiver.
- ◆ Use only the supplied DC power cable or a **KENWOOD** optional DC power cable.
- ◆ Do not cut and/or remove the fuse holder on the DC power cable.

- 1 Check for an existing hole, conveniently located in the firewall, where the power cable can be passed through. If no hole exists, use a circle cutter to drill the firewall, then install a rubber grommet.
- 2 Run the two power cable leads through the firewall and into the engine compartment, from the passenger compartment.
- 3 Connect the red lead to the positive (+) battery terminal and the black lead to the negative (-) battery terminal.
 - Locate the fuse as close to the battery as possible.
- 4 Coil and secure the surplus cable with a retaining band.
 - Be sure to leave enough slack in the cables so the transceiver can be removed for servicing while keeping the power applied.

INSTALLING THE TRANSCEIVER



WARNING

For passenger safety, install the transceiver securely using the supplied mounting bracket and screw set so the transceiver will not break loose in the event of a collision.

- 1 Mark the position of the holes in the dash by using the mounting bracket as a template. Drill the holes, then attach the mounting bracket using the supplied self-tapping screws.
 - Be sure to mount the transceiver in a location where the controls are within easy reach of the user and where there is sufficient space at the rear of the transceiver for cable connections.
- 2 Connect the antenna and the supplied power cable to the transceiver.
- 3 Slide the transceiver into the mounting bracket and secure it using the supplied hex-headed screws.
- 4 Mount a microphone hanger in a location where it will be within easy reach of the user.
 - The optional microphone and microphone cable should be mounted in a place where they will not interfere with the safe operation of the vehicle.



CAUTION

When replacing the fuse in the DC power cable, be sure to replace it with a fuse of the same value. Never replace a fuse with a fuse that has a higher value.

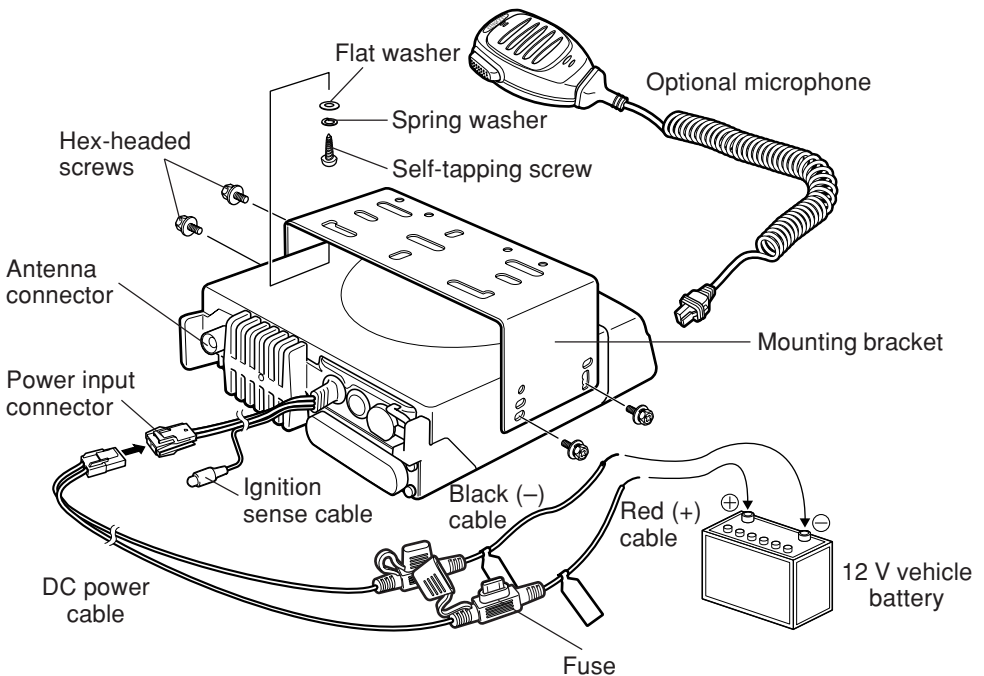

GETTING ACQUAINTED

FRONT PANEL

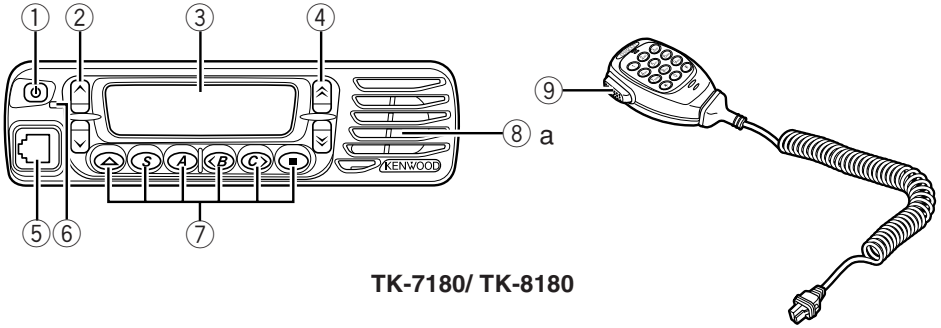

TK-7180/ TK-8180

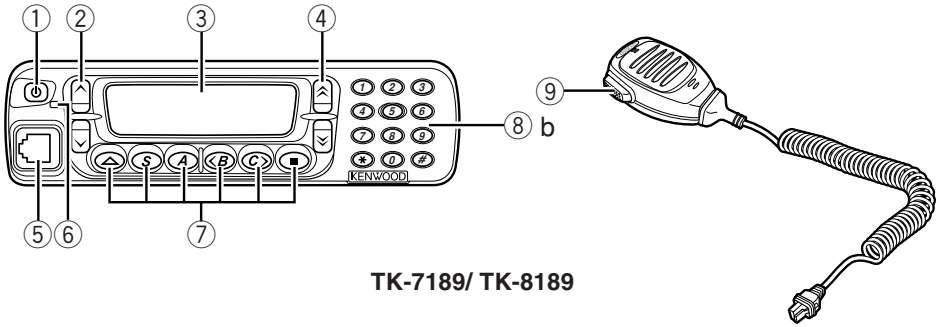

TK-7189/ TK-8189

REAR PANEL

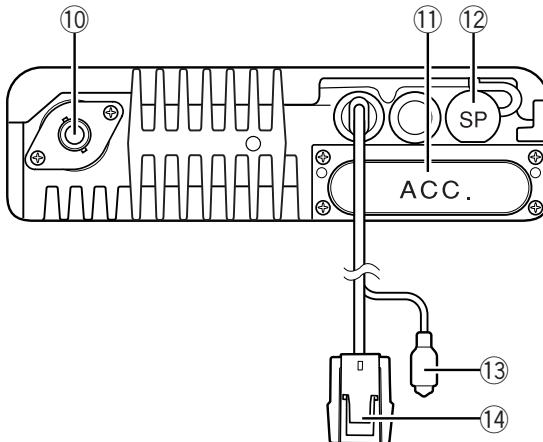

- ① **⏻ (Power) switch**
Press to switch the transceiver ON. Press again to switch the transceiver OFF.
- ② **^ / v keys**
Press to activate their programmable functions {page 7}.
- ③ **Display**
Refer to page 6.
- ④ **^ / v keys**
Press to activate their programmable functions {page 7}.
- ⑤ **Microphone jack**
Insert the microphone plug into this jack.
- ⑥ **Transmit/ Busy/ Call indicator**
Lights red while transmitting, green while receiving, and orange while receiving a call using optional signaling.
- ⑦ **△, S, A, <B, C>, ■ keys**
Press to activate their programmable functions {page 7}.
- ⑧
 - a) **Speaker (TK-7180/ TK-8180)**
Internal speaker.
 - b) **DTMF Keypad (TK-7189/ TK-8189)**
Press the keys on the keypad to make DTMF calls {page 18} or to activate their programmable functions {page 7}.
- ⑨ **PTT (Push-to-Talk) switch**
Press and hold this switch, then speak into the optional microphone to call a station.
- ⑩ **Antenna connector**
Attach the vehicle antenna to this connector {page 3}.
- ⑪ **ACC. (accessory) connector**
Connect external KENWOOD accessories to this connector.
- ⑫ **SP (speaker) jack**
Connect an external speaker to this jack.
- ⑬ **Ignition sense line**
Connect the vehicle ignition sensor to this line.
- ⑭ **Power input connector**
Attach the supplied DC power cable to this connector {page 3}.

DISPLAY

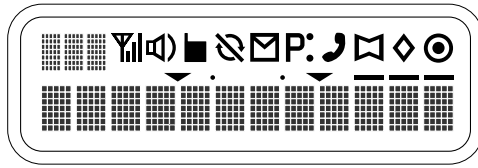

Indicator	Description
	Displays the zone and channel numbers. Your dealer can program zone and channel names with up to 12 characters, in place of numbers. Also displays received 5-tone and FleetSync messages.
	Displays the zone and channel numbers. Also displays list numbers for Operator Selectable Tones.
	Displays the strength of received signals. An antenna and all 3 strength bars represents strong signals while the antenna by itself (no strength bars) represents weak signals.
	Appears when Monitor or Squelch Off is activated.
	Appears when the Talk Around function has been activated.
	Appears when you are using Scan mode or when the selected zone is a Voting or Free Channel Call zone.
	Flashes when you receive a message. Lights when a message is stored in the queue memory.
	Appears when the selected channel is programmed as priority. P: represents Priority Channel 1, P. represents Priority Channel 2, and P: represents Priority Channels 1 and 2.
	This icon is not used on this transceiver.
	Appears when the Horn Alert function is activated.
	Appears when the Scrambler function is activated.
	Appears when the Public Address function is activated.
	Appears when the selected zone is added to the scanning sequence.
	Appears when the Auto Recording function on the VGS-1 option is activated.
	Appears when an Auto Reply Message on the VGS-1 option is activated.
	Appears when the selected channel is added to the scanning sequence.
	Appears when the AUX A function has been activated.
	Appears when the AUX B function has been activated.
	Appears when the OST function has been activated.

PROGRAMMABLE FUNCTIONS

The ^, v, ^, v, ^, S, A, <B, C>, ■, DTMF (TK-7189/ TK-8189 only) keys, and optional microphone with DTMF keypad can be programmed with the functions listed below. Please contact your dealer for further details on these functions.

- Auto Reply Message ^{1, 2}
- Autodial
- Autodial Programming
- AUX A
- AUX B
- Call 1 ~ Call 6
- CH/GID Down
- CH/GID Down (Continuous)
- CH/GID Recall
- CH/GID Up
- CH/GID Up (Continuous)
- Channel Entry
- Clock
- Digit 1x Down ³
- Digit 10x Down ³
- Digit 1x Up ³
- Digit 10x Up ³
- Direct CH/GID 1 ~ 5
- Direct CH/GID 1 ~ 5 Select
- Display Character
- Emergency ⁴
- Fixed Volume
- Function
- Home CH/GID
- Home CH/GID Select
- Horn Alert
- LCD Brightness
- Lone Worker
- Monitor
- Monitor Momentary
- None
- OST
- Playback ²
- Priority Channel Select
- Public Address
- Queue
- Receive Entry ³
- Scan
- Scan Delete/Add
- Scrambler
- Scrambler Code
- Selcall
- Selcall + Status
- Send the GPS data ¹
- Squelch Level
- Squelch Off
- Squelch Off Momentary
- Status
- Talk Around
- Transceiver Password
- Transfer ³
- Voice Memo ²
- Volume Down
- Volume Down (Continuous)
- Volume Up
- Volume Up (Continuous)
- Zone Delete/Add
- Zone Down
- Zone Down (Continuous)
- Zone Up
- Zone Up (Continuous)

¹ "Auto Reply Message" and "Send the GPS data" can be used only for FleetSync.

² "Auto Reply Message", "Playback", and "Voice Memo" can be programmed only when the optional VGS-1 board has been installed.

³ "Digit 1x Down", "Digit 10x Down", "Digit 1x Up", "Digit 10x Up", "Receive Entry", and "Transfer" can be programmed only for 5-tone calls.

⁴ "Emergency" can be programmed only on the ^ key.

BASIC OPERATIONS

OVERVIEW

Your dealer can program your transceiver with Conventional, Voting, Voting with Signaling, and Free Channel Call zones. The transceiver can handle up to 128 zones with up to 250 channels in each zone and a total combined maximum of 512 channels. Zones, channels, and their functions are programmed by your dealer.

SWITCHING POWER ON/ OFF

Press the **⏻** switch to switch the transceiver ON.

- A beep sounds and the display momentarily lights up.
- If the Transceiver Password function is programmed, "PASSWORD" appears on the display. You must enter the password to unlock the transceiver. Refer to "Transceiver Password", below.

Press the **⏻** switch again to switch the transceiver OFF.

■ TRANSCEIVER PASSWORD

To enter the password:

- 1 Press the **⤴** and **⤵** keys to select a digit.
- 2 Press the **C>** key to accept the entered digit and move to the next digit.
 - Press the **A** key to delete an incorrect character. Press and hold the **A** key to delete all entered characters.
 - Repeat steps 1 and 2 to enter the entire password.
- 3 Press the **S** key to confirm the password.
 - If you enter an incorrect password, an error tone sounds and the transceiver remains locked.

To enter the password using a DTMF keypad:

- 1 Press the DTMF keys corresponding to the password digits.
 - Press the DTMF **#** key to delete an incorrect character. Press and hold the DTMF **#** key to delete all entered characters.
- 2 Press the DTMF ***** key to confirm the password.
 - If you enter an incorrect password, an error tone sounds and the transceiver remains locked.

ADJUSTING THE VOLUME

Press the key programmed as **Volume Up** to increase the volume and **Volume Down** to decrease the volume.

SELECTING A ZONE AND CHANNEL

Select the desired zone using the keys programmed as **Zone Up** and **Zone Down**.

Select the desired channel using the keys programmed as **CH/GID (Channel/ Group ID) Up** and **CH/GID (Channel/ Group ID) Down**.

Names can be programmed for zones and channels with up to 12 characters each. However, to fit on the display, names will be abbreviated. Your dealer can set the zone name to a length of 0 to 12 digits. Channel names will shorten appropriately, to fit in the 12-digit display.

For example, if the channel name is “-CHANNEL1-” and the zone name is “KENWOOD”, and your dealer sets the zone name to 3-digits, the following display will appear:

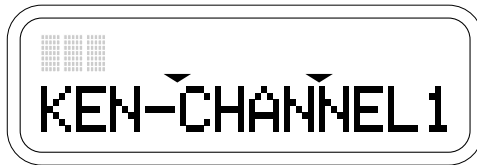

TRANSMITTING

- 1 Select the desired zone and channel using the **Zone** and **CH/GID** keys.
 - In Voting, Voting with Signaling, and Free Channel Call zones, the channel is selected automatically.
- 2 In Conventional zones, press the key programmed as **Monitor** or **Squelch Off** to check whether or not the channel is free.
 - If the channel is busy, wait until it becomes free.
- 3 Press microphone **PTT** switch and speak into the microphone. Release the **PTT** switch to receive.
 - For best sound quality at the receiving station, hold the microphone approximately 1.5 inches (3 ~ 4 cm) from your mouth.
 - In Voting and Voting with Signaling zones, the transceiver will search for the closest repeater and transmit using that repeater's frequency.
 - In Free Channel Call zones, the transceiver will search for a free channel and will begin transmitting on that channel.

RECEIVING



- 1 Select the desired zone and channel using the **Zone** and **CH/GID** keys.
 - Alternatively, in Conventional zones, you can activate the Scan function if desired.
 - In Voting and Voting with Signaling zones, the transceiver will automatically search for the strongest signal and receive on that frequency.
 - In Free Channel Call zones, the transceiver will automatically search for any signal and will receive on that channel.
- 2 When you hear a caller's voice, readjust the volume as necessary.

CONVENTIONAL SCAN

If the Scan function is programmed, Conventional zones or channels can be scanned by pressing the key programmed as **Scan**. Scan can be used as either Single Scan or Multi Scan.

- Single Scan monitors only the channels of the currently selected zone, which have been added to the scanning sequence. If set up to scan Priority channels, the Priority channels will be scanned even if they are not within the currently selected zone.
- Multi Scan monitors all channels of every zone, which have been added to the scanning sequence.

To activate Scan, press the key programmed as **Scan**.

- The  icon and "SCAN" or the revert zone and channel number appear on the display.
- The zone add indicator () will appear on the display when the selected zone is added to the scan sequence. The channel add indicator () will appear on the display when the selected channel is added to the scan sequence.
- When a call is received, scanning stops and the zone and channel digits appear. Press the microphone **PTT** switch and speak into the microphone to respond to the call. The transceiver will continue scanning after a predetermined time delay if the **PTT** switch is released and no further signal is received.

To stop scanning, press the **Scan** key again.

ADD TO SCAN/ DELETE FROM SCAN

Press the key programmed as **Scan Delete/Add** to add or remove each channel to or from the scan sequence.

- The channel add indicator () will appear on the display when the selected channel is added to the scan sequence.

Press the key programmed as **Zone Delete/Add** to add or remove each zone to or from the scan sequence.

- The zone add indicator () will appear on the display when the selected zone is added to the scan sequence.

SCAN REVERT

You can select Revert zones and channels using the **Zone** and **CH/GID** keys.

Eight types of Scan Reverts which can be programmed by your dealer are available.

- **Last Called Revert:** The last zone/ channel received is assigned as the new revert zone and channel.
- **Last Used Revert:** The last zone/ channel responded to is assigned as the new revert zone and channel.
- **Selected:** The last zone/ channel selected is assigned as the new revert zone and channel.
- **Selected + Talkback:** If the zone/ channel has been changed during Scan, the newly selected zone/ channel is assigned as the new revert zone and channel. The transceiver “talks back” on the current receive channel.
- **Priority 1:** If your dealer has programmed a Priority 1 channel, this channel is the revert zone and channel.
- **Priority 1 + Talkback:** If your dealer has programmed a Priority 1 channel, this channel is the revert zone and channel. The transceiver “talks back” on the current receive channel.
- **Priority 2:** If your dealer has programmed a Priority 2 channel, this channel is the revert zone and channel.
- **Priority 2 + Talkback:** If your dealer has programmed a Priority 2 channel, this channel is the revert zone and channel. The transceiver “talks back” on the current receive channel.

PRIORITY SCAN

A Priority channel must be programmed in order for Priority Scan to function.

The transceiver will automatically change to the Priority channel when a signal is received on it, even if a signal is being received on a normal channel.

- The **P** indicator represents the Priority 1 channel.
- The **P** indicator represents the Priority 2 channel.
- The **P:** indicator represents both the Priority 1 and Priority 2 channel.

QUIET TALK (QT)/ DIGITAL QUIET TALK (DQT)

Your dealer may have programmed QT or DQT signaling on your transceiver channels. A QT tone/ DQT code is a sub-audible tone/code which allows you to ignore (not hear) calls from other parties who are using the same channel.

When a channel is set up with a QT tone or DQT code, squelch will open only when a call containing a matching tone or code is received. Likewise, signals that you transmit will be heard only by parties whose QT/ DQT signaling matches your transceiver.

If a call containing a different tone or code is made on the same channel you are using, squelch will not open and you will not hear the call. Although it may seem like you have your own private channel while using QT/ DQT, other parties can still hear your calls if they set up their transceiver with the same tone or code.

OPERATOR SELECTABLE TONE (OST)

You can change the preset encode and decode tones for the selected channel. Your dealer can program up to 40 tones on your transceiver.

To turn OST on or off, press the key programmed as **OST**.

- The OST indicator (■■■■■■■■■) appears on the display when this function is activated.

To change the preset encode/decode tones:

- 1 Press and hold the key programmed as **OST**.
 - The duration for holding the **OST** key is programmed by your dealer.
 - The OST number and name appear on the display.
- 2 Press the **<B** and **C>** keys or enter the list number directly using a DTMF keypad to select your desired encode/decode pair.
 - If programmed by your dealer, you can also use the **∧** and **∨** keys.
- 3 Press the **S** or DTMF ***** key to accept the new setting and return to normal operation.

5-TONE SIGNALING

5-tone Signaling is enabled or disabled by your dealer. This function opens the squelch only when the transceiver receives the 5 tones programmed in your transceiver. Transceivers that do not transmit the correct tones will not be heard.

Note: Your transceiver functions include either 5-tone Signaling or FleetSync (page 15), but not both.

MAKING A SELCALL (SELECTIVE CALLING)

A Selcall is a voice call to a particular station. To make a Selcall:

- 1 Select your desired zone and channel.
- 2 Press the key programmed as **Selcall** or **Selcall + Status** to enter Selcall Mode.
- 3 Press the **<B and C>** keys to select the ID of the station you want to call.
 - If programmed by your dealer, you can also use the **↗** and **↘** keys.
 - Alternatively, you can enter a station ID using a DTMF keypad.
 - If Manual Input Mode is enabled, you can enter digits by using a DTMF keypad or by selecting digits with the **↗** and **↘** keys. To enter manual input mode, first press and hold the **S** or DTMF ***** key. When using the **↗** and **↘** keys, cycle through the digits to select a digit. The cursor can be shifted to the left or right by pressing the **<B or C>** key. Repeat this process until the entire ID is entered.
- 4 Press the key programmed as **Call 1** to **Call 6** to begin your call.

TRANSMITTING A STATUS MESSAGE

Status messages can contain up to 16 alphanumeric characters. To transmit a Status message:

- 1 Select your desired zone and channel.
- 2 Press the key programmed as **Status** to enter Status Mode or **Selcall + Status** to enter Selcall Mode.
 - When using the **Status** key to enter Status Mode, the station ID is fixed and cannot be selected. Skip to step 5 to continue.
- 3 In Selcall Mode, press the **<B and C>** keys to select the ID of the station you want to call.
 - If programmed by your dealer, you can also use the **↗** and **↘** keys.
 - Alternatively, you can enter a station ID using a DTMF keypad.
 - If Manual Input Mode is enabled, you can enter digits by using an optional DTMF keypad or by selecting digits with the **↗** and **↘** keys. To enter manual input mode, first press and hold the **S** or DTMF ***** key. When using the **↗** and **↘** keys, cycle through the digits to select a digit. The cursor can be shifted to the left or right by pressing the **<B or C>** key. Repeat this process until the entire ID is entered.
- 4 Press the **S** or DTMF ***** key to enter Status Mode.

- 5 Press the **<B and C>** keys to select the status ID you want to transmit.
 - If programmed by your dealer, you can also use the **∧** and **∨** keys.
 - Alternatively, you can enter a station ID using a DTMF keypad.
 - If Manual Input Mode is enabled, you can enter digits by using an optional DTMF keypad or by selecting digits with the **∧** and **∨** keys. To enter manual input mode, first press and hold the **S** or DTMF ***** key. When using the **∧** and **∨** keys, cycle through the digits to select a digit. The cursor can be shifted to the left or right by pressing the **<B or C>** key. Repeat this process until the entire ID is entered.
- 6 Press the **Call 1 to Call 6** key to initiate the Status call.

RECEIVING SELCALLS AND STATUS MESSAGES

When you receive a signal containing the correct tones, squelch opens and you will hear the call.

- The LED indicator flashes orange.
- To mute the speaker after squelch opens, press the key programmed as **Monitor**.
- Your dealer can program the Monitor function to close again after a specific time period elapses.
- If Transpond for 5-tone Signaling is programmed, an acknowledgement signal is returned to the calling station.
- If Call Alert for 5-tone Signaling is programmed, an alert tone will sound when the correct tones are received.
- Your dealer can program the transceiver to display the received Selcall/Status.

To respond to the call, press the microphone **PTT** switch and speak into the microphone.

REVIEWING MESSAGES IN THE QUEUE MEMORY

A maximum of 15 received messages can be stored in the Queue memory of your transceiver. Saved messages can be viewed after reception. When the Queue memory is full, the oldest message will be erased when a new message is received.

Then **☒** icon lights when a message is stored in the Queue memory.

- 1 Press the key programmed as **Queue** to enter Queue Mode.
- 2 Press the **<B and C>** keys to select the desired message.
 - If programmed by your dealer, you can also use the **∧** and **∨** keys.
 - Press and hold the **S** or DTMF ***** key to toggle between the called ID/ status ID, the channel name, and the time of the received message.
- 3 Press the **S** or DTMF ***** key to return to Normal Operation Mode.
 - To delete the selected message, press the **A** or DTMF **#** key. To confirm the deletion, press the **S** or DTMF ***** key.
 - To delete all messages, press and hold the **A** or DTMF **#** key for 1 second. To confirm the deletion, press the **S** or DTMF ***** key.

FleetSync: ALPHANUMERIC 2-WAY PAGING FUNCTION

FleetSync is an Alphanumeric 2-way Paging Function, and is a protocol owned by **KENWOOD** Corporation. FleetSync enables a variety of paging functions on your transceiver, some of which depend on dealer programming.

Note: Your transceiver functions include either Fleetsync or 5-tone Signaling {page 13}, but not both.

SELCALL (SELECTIVE CALLING)

A Selcall is a voice call to a particular station or to a group of stations.

■ TRANSMITTING

- 1 Select your desired zone and channel.
- 2 Press the key programmed as **Selcall** or **Selcall + Status** to enter Selcall Mode.
- 3 Press the **<B** and **C>** keys to select the ID of the station you want to call.
 - If programmed by your dealer, you can also use the **∧** and **∨** keys.
 - Alternatively, you can enter a station ID using a DTMF keypad.
 - If Manual Input Mode is enabled, you can enter digits by using a DTMF keypad or by selecting digits with the **∧** and **∨** keys. To enter manual input mode, first press and hold the **S** or DTMF ***** key. When using the **∧** and **∨** keys, cycle through the digits to select a digit, then press the **C>** key to accept the digit and shift the cursor to the right. Repeat this process until the entire ID is entered.
- 4 Press the microphone **PTT** switch and begin your conversation.
 - Alternatively, you can press the **■** key to page the selected station, rather than making a voice call.

■ RECEIVING

An alert tone will sound, the transceiver will automatically enter Selcall Mode, and the calling station's ID will appear when a Selcall is received.

To respond to the call, press the microphone **PTT** switch and speak into the microphone.

■ IDENTIFICATION CODES

An ID code is a combination of a 3-digit Fleet number and a 4-digit ID number. Each transceiver must have its own Fleet and ID number.

- Enter a Fleet number (100 ~ 349) to make a group call.
- Enter an ID number (1000 ~ 4999) to make an individual call in your fleet.
- Enter a Fleet number make a call to all units in the selected fleet (Interfleet call).
- Select "ALL" Fleet and enter an ID number to make a call to the selected ID in all fleets (Supervisor call).
- Select "ALL" Fleet and "ALL" ID to make a call to all units (Broadcast call).













Note: The ID range may be limited by programming.

STATUS MESSAGE

You can send and receive 2-digit Status messages which may be decided in your talk group. Messages can contain up to 16 alphanumeric characters. Status messages range from 10 to 99 (80 ~ 99 are reserved for special messages).

A maximum of 15 received messages can be stored in the Queue memory of your transceiver. These saved messages can be reviewed after reception. Depending on your dealer settings, when the Queue memory is full, either the oldest message will be erased when a new message is received or the new message will not be stored in the Queue memory. The  icon lights when a message is stored in the Queue memory.

■ TRANSMITTING

- 1 Select your desired zone and channel.
- 2 Press the key programmed as **Status** to enter Status Mode or **Selcall + Status** to enter Selcall Mode.
 - When using the **Status** key to enter Status Mode, the station ID is fixed and cannot be selected. Skip to step 5 to continue.
- 3 In Selcall Mode, press the **<B and C>** keys to select the ID of the station you want to call.
 - If programmed by your dealer, you can also use the  and  keys.
 - Alternatively, you can enter a station ID using a DTMF keypad.
 - If Manual Input Mode is enabled, you can enter digits by using a DTMF keypad or by selecting digits with the  and  keys. To enter manual input mode, first press and hold the **S** or DTMF ***** key. When using the  and  keys, cycle through the digits to select a digit, then press the **C>** key to accept the digit and shift the cursor to the right. Repeat this process until the entire ID is entered.
- 4 Press the **S** or DTMF ***** key to enter Status Mode.
- 5 Press the **<B and C>** keys to select the status ID you want to transmit.
 - If programmed by your dealer, you can also use the  and  keys.
 - Alternatively, you can enter a station ID using a DTMF keypad.
 - If Manual Input Mode is enabled, you can enter digits by using a DTMF keypad or by selecting digits with the  and  keys. To enter manual input mode, first press and hold the **S** or DTMF ***** key. When using the  and  keys, cycle through the digits to select a digit, then press the **C>** key to accept the digit and shift the cursor to the right. Repeat this process until the entire ID is entered.
- 6 Press the microphone **PTT** switch or  key to initiate the Status call.
 - “**«COMPLETE»**” is displayed when the call has been successfully transmitted.

■ RECEIVING

The  icon will flash and a calling ID or text message will appear when a Status call is received.

Press any key to return to Normal Operation Mode.

■ REVIEWING MESSAGES IN THE QUEUE MEMORY

- 1 Press the key programmed as **Queue** to enter Queue Mode.
 - The last received message is displayed with the message number.
- 2 Press the **<B and C>** keys to select the desired message.
 - If programmed by your dealer, you can also use the **^** and **∨** keys.
 - Press and hold the **S** or DTMF ***** key to toggle between the message/ call ID, the channel name, and the time of the received message.
- 3 Press the **S** or DTMF ***** key to return to Normal Operation Mode.
 - To delete the selected message, press the **A** or DTMF **#** key. To confirm the deletion, press the **S** or DTMF ***** key.
 - To delete all messages, press and hold the **A** or DTMF **#** key for 1 second. To confirm the deletion, press the **S** or DTMF ***** key.

SHORT MESSAGES

To send a short message, you must connect the transceiver to a PC. Ask your dealer for details.

- Short messages can contain a maximum of 48 characters.
- Received short messages are displayed the same as Status messages and are stored in the same Queue memory. A combined maximum of 15 Status calls and short messages can be stored in the Queue memory.

LONG MESSAGES

To send and receive long messages, you must connect the transceiver to a PC. Ask your dealer for details.

- Long messages can contain a maximum of 4096 characters.

GPS REPORT

To send your location data, you must first install a GPS unit (NMEA-0183 format) onto the transceiver. Press the key programmed as **Send the GPS data** to transmit your location data. Ask your dealer for details.

DTMF (DUAL TONE MULTI FREQUENCY) CALLS

MANUAL DIALING

TK-7180/ TK8180 Models: To make a DTMF call using manual dialing, you must use an optional microphone with a DTMF keypad.

■ METHOD 1

Press and hold the microphone **PTT** switch, then enter the desired digits using a DTMF keypad.

- If you release the **PTT** switch, transmit mode will end even if the complete number has not been sent.
- If your dealer has activated the Keypad Auto PTT function, you need not press the **PTT** switch while entering digits. The DTMF code will be sent automatically when you press a key.

■ METHOD 2

Enter the desired digits using a DTMF keypad (maximum of 30 digits). After entering the complete number, press the microphone **PTT** switch.

- The DTMF code is transmitted after pressing the **PTT** switch.

Note: Switching OFF the transceiver power clears the number.

AUTODIAL

Autodial allows you to store and quickly recall 32 names (up to 12 characters per name) and DTMF numbers (up to 16 digits per number).

REDIAL

TK-7180/ TK-8180 Models: To redial a number, you must use an optional microphone with a DTMF keypad.

- 1 To redial the last called number, press the key programmed as **Autodial**.
 - The first entry in the Autodial list appears on the display.
- 2 Press the DTMF * key followed by the DTMF 0 key to display the last called number.
- 3 Press the microphone **PTT** switch to make the call.

Note: Switching OFF the transceiver power clears the redial memory.

CONNECT/ DISCONNECT IDs

TK-7180/ TK-8180 Models: To transmit connect/ disconnect IDs, you must use an optional microphone with a DTMF keypad.

- 1 Press the key programmed as **Autodial**.
 - The first entry in the Autodial list appears on the display.
- 2 Connect ID: Press the DTMF * key two times.
Disconnect ID: Press the DTMF * key followed by the DTMF # key.
- 3 Press the microphone **PTT** switch to make the call.

DTMF SIGNALING

DTMF Signaling is either enabled or disabled by your dealer. This function opens the squelch only when the transceiver receives the DTMF code programmed in your transceiver. Each transceiver is normally programmed with a unique code. You will not hear calls from transceivers that are not programmed with a matching code.

When you receive a signal containing the correct tones, squelch opens and you will hear the call.

- The LED indicator flashes orange.
- To mute the speaker after squelch opens, press the key programmed as **Monitor**.
- Your dealer can program the squelch to close again after a specific time period elapses.
- If Transpond for DTMF Signaling is programmed, an acknowledgment signal is returned to the calling station.
- If Tone Alert for DTMF Signaling is programmed, an alert tone will sound when the correct tones are received.

STUN

This function is used when a transceiver is stolen or lost. When the transceiver receives a call containing a stun code, either transmit mode will be disabled or both receive mode and transmit mode will be disabled. Stun is cancelled when the transceiver receives a call with a revive code.

EMERGENCY CALLS

If your transceiver has been programmed with the Emergency function, you can make emergency calls.

Note: Only the \triangle key can be programmed with the Emergency function.

1 Press and hold the key programmed as **Emergency**.

- Depending on the delay time programmed into your transceiver, the length of time you must hold the **Emergency** key will vary.
- When the transceiver enters Emergency mode, the transceiver will change to the Emergency channel and begin transmitting based on how the transceiver is set up by your dealer. Transmit periods are also set by your dealer.

2 To exit Emergency mode, press and hold the **Emergency** key again.

- If the Emergency mode completes the preset number of cycles, Emergency mode will automatically end and the transceiver will return to the channel that was in use before Emergency mode was entered.

Note:

- ◆ Your dealer can set a beginning of transmit and end of transmit tone for the transceiver.
 - ◆ Your dealer can set the transceiver to emit tones and received signals as normal or mute the speaker during Emergency operation.
-

ADVANCED OPERATIONS

TALK AROUND

You may occasionally experience an interruption in service (due to a power failure, etc.). During such an occurrence, you can continue communication by using the Talk Around feature. Talk Around allows you to communicate directly with other transceivers, without the use of a repeater. However, if the station you want to contact is too far away, or there are geographical obstacles in the way, you may not be able to contact the station.

Toggle Talk Around ON and OFF by pressing the key programmed as **Talk Around**.

- The **■** icon appears on the display while Talk Around is active.
- When using Talk Around, the receive frequency is used for both transmitting and receiving, and the decode signaling is used for both encoding and decoding.

MONITOR/ SQUELCH OFF

You can use the key programmed as **Monitor/ Squelch Off** to listen to weak signals that you cannot hear during normal operation and to adjust the volume when no signals are present on your selected channel.

- The **🔊** icon appears on the display while Monitor/ Squelch Off is activated.

Your dealer can program a key with one of 4 functions:

- **Monitor:** Momentarily press to deactivate QT, DQT, DTMF, 5-tone, or FleetSync Signaling. Press the key again to return to normal operation.
- **Monitor Momentary:** Press and hold to deactivate QT, DQT, DTMF, 5-tone, or FleetSync Signaling. Release the key to return to normal operation.
- **Squelch Off:** Momentarily press to hear background noise. Press the key again to return to normal operation.
- **Squelch Off Momentary:** Press and hold to hear background noise. Release the key to return to normal operation.

■ SQUELCH LEVEL

To adjust the squelch level:

- 1 Press the key programmed as **Squelch Level**.
- 2 Press the **<B** key to decrease the squelch level (open) and the **C>** key to increase the squelch level (tighten).
 - If programmed by your dealer, you can also use the **∨** and **∧** keys.
- 3 Press the **S** or DTMF ***** key to store the new setting and exit the squelch level adjustment.

SCRAMBLER

Although the scrambler function does not offer complete privacy with your calls, it does prevent others from easily listening in on your calls. When activated, the transceiver distorts your voice so that anybody listening to your conversation will be unable to clearly hear what you are saying.

In order for members of your own group to clearly hear your call while you are using the scrambler, all other members must also activate the scrambler functions on their transceivers. This distorts everybody's voice while transmitting and corrects the voice message on your own transceiver when you receive the call.

To activate the scrambler, press the key programmed as **Scrambler**.

- The **◇** icon appears on the display while the scrambler is active.

To deactivate the scrambler, press the **Scrambler** key again.

Note: There are 2 options for using the scrambler. Your dealer can activate or deactivate the built-in scrambler function of the transceiver, or they can add a more secure optional scrambler board to your transceiver. Ask your dealer for details.

CLOCK

If activated by your dealer, your transceiver can track the time and date with its built-in clock. The time will display momentarily when the transceiver power is turned ON. Additionally, you can view the clock any time by pressing the key programmed as **Clock**.

Note: Removing the transceiver power for extended periods will cause the clock time to clear.

■ CLOCK SETUP

To set the year, month, day, and time:

- 1 With the transceiver power OFF, press and hold the **C>** key while turning the transceiver power ON.
 - The current year setting appears.
- 2 Press the **∧** and **∨** keys to select the year, then press the **S** key to cycle to the month setting.
 - Repeat this step, to cycle through the day, hour, and minute settings.
- 3 Press the **S** key again, to return to the year setting.
 - A triple beep will sound, indicating that your selections have been set into the transceiver memory.
- 4 Turn the transceiver power OFF and then back ON to return to Normal Operation Mode.

LCD BRIGHTNESS

The LCD backlight can be turned off or set to low or high levels. To cycle through the brightness settings, press the key programmed as **LCD Brightness**.

- Each press of **LCD Brightness** cycles the brightness level from high to low to off and then back to high.

HORN ALERT

To use the Horn Alert function, your dealer must install an optional KAP-2 unit. When a call is received that has a correct DTMF, 5-tone, or FleetSync signal, Horn Alert causes the vehicle horn or some other external alert to sound. This function notifies you of a received call when you are out of your vehicle.

Toggle Horn Alert ON and OFF by pressing the key programmed as **Horn Alert**.

- The  icon appears on the display while Horn Alert is active.

PUBLIC ADDRESS (PA)

To use the Public Address system, your dealer must install an optional KAP-2 unit and an external speaker. This function causes all audio input via the microphone to be amplified and output from the external speaker.

To use the PA system:

- 1 Press the key programmed as **Public Address**.
 - The  icon appears on the display while the PA system is active.
- 2 Press the microphone **PTT** switch, then speak into the microphone.
 - Use the **Volume Up** and **Volume Down** keys to adjust the audio output from the external speaker.
- 3 Press the **Public Address** key again to return to Normal Operation Mode.

BACKGROUND OPERATIONS

TIME-OUT TIMER (TOT)

The purpose of the Time-out Timer is to prevent any caller from using a channel for an extended period of time.

If you continuously transmit for a period of time that exceeds the programmed time set by your dealer (default is 1 minute), the transceiver will stop transmitting and an alert tone will sound. To stop the tone, release the microphone **PTT** switch.

Your dealer can program the TOT time in the range of 15 seconds to 20 minutes.

BUSY CHANNEL LOCKOUT (BCL)





When activated, BCL prevents you from interfering with other parties who may be using the same channel that you selected. Pressing the microphone **PTT** switch while the channel is in use will cause your transceiver to emit an alert tone and transmission will be inhibited (you cannot transmit). Release the **PTT** switch to stop the tone and return to receive mode.

If activated, you can override this function. To override BCL, press the microphone **PTT** switch again immediately after releasing it (within half a second).

Note: Ask your dealer for an explanation on how BCL functions when using QT, DQT, DTMF, 5-tone, or FleetSync signaling.

SIGNAL STRENGTH INDICATOR

The signal strength indicator displays the strength of received calls:

-  Strong signal
-  Medium signal
-  Weak signal
-  Very weak signal

BEGINNING/ END OF TRANSMIT SIGNAL

The Beginning of Transmit and End of Transmit identification signals are used to access and release some repeaters.

If Beginning of Transmit is set, the ID signal is transmitted when you press the microphone **PTT** switch.

If End of Transmit is set, the ID signal is transmitted when you release the microphone **PTT** switch.

If both are set, the ID signal is transmitted when you press and release the microphone **PTT** switch.

VGS-1 OPTIONAL VOICE GUIDE & STORAGE UNIT

When using the optional VGS-1 voice guide & storage unit, you gain access to the voice recorder and voice announcement functions. Ask your dealer for details.

VOICE RECORDER

The voice recorder function allows you to record your conversations and create voice memos and automated message responses.

■ AUTO RECORDING

If activated, the auto recording function will continuously record all transmitted and received signals. The recording storage area retains 30 seconds of recording, so all transmitted and received signals are simultaneously recorded and erased, leaving only the last 30 seconds of recording in memory.

- The auto recording indicator (■■■■■■■■■■) appears when this function is activated.

■ VOICE MEMOS

To record a voice memo, for later playback:

- 1 Press the key programmed as **Voice Memo**.
 - The duration of recording memory will appear on the display and begin counting down.
- 2 Speak into the microphone to record your voice memo.
- 3 Press the **■**, **S**, or DTMF ***** key to end the recording at any time and store it into the transceiver memory.
 - If the memory becomes full, recording will stop automatically and store the voice memo to memory.
 - "WRITING" appears on the display while the recording is being stored to memory.

■ AUTO REPLY MESSAGE

You can set the transceiver to automatically respond to Individual Calls (while using FleetSync):

- 1 Press the key programmed as **Auto Reply Message** to enter Auto Reply Message mode.
 - The Auto Reply Message indicator (■■■■■■■■■■) appears on the display.
- 2 When you receive an Individual Call, Auto Reply will begin after waiting for 3 seconds, the transceiver will send an automatic response to the caller, and “GREETING” appears on the display.
 - If you are available to receive the call, press any key to disable the auto response.
 - If memory is available on your transceiver for recording, “I am not available. Leave your Message.” will be sent to the caller. The caller can then leave a recorded message on your transceiver which you can later recall and listen to. When a message is stored on your transceiver, “Msg Rcvd” appears on the display.
 - If no memory is available on your transceiver for recording, “I am not available.” will be sent to the caller and “MEMORY FULL” appears on the display.

■ PLAYBACK

To play back a recorded conversation, memo, or message:

- 1 Press the key programmed as **Playback** to enter Playback mode.
 - If the last action on your transceiver was to auto record your conversation, “STORE?” will appear on the display, otherwise a recording channel with the time of the recording will appear. To store the conversation record in the next available recording channel, press the ■ key. To clear the conversation, press the **A** or DTMF # key. To skip to the stored recording channels, press the **S** or DTMF * key. To skip back 5 seconds, press the <**B** key. To skip ahead 5 seconds, press the **C**> key.
- 2 Press the ^ and v keys to select the channel which you want to play back.
 - “RM” represents automated reply messages.
 - “RR” represents conversation records.
 - “UM” represents voice memos.
- 3 The transceiver will announce the channel, then the recording will automatically play back.
 - When the entire recording has been played, “END OF MSG” (end of message) is displayed.
 - To delete the selected recording, press the **A** or DTMF # key. To clear all the recorded data, press and hold the **A** or DTMF # key. A confirmation message will appear on the display. Press the **S** or DTMF * key to delete the recording(s) or the **A** or DTMF # key to cancel.

VOICE GUIDE

When changing the zone, channel, or operation mode, an audio voice will announce the new zone, channel, or mode, after it has been selected. (Voice Annunciation can be activated or deactivated by your dealer.)

KENWOOD

Apex Radio Systems Ltd.
102 Tantobie Road
Denton Burn
Newcastle upon Tyne
NE15 7DQ

Tel 0191 228 0466
Fax 0191 228 0467
Email info@apexradio.com



CE 0168 Ⓢ